

ITEM.	NR.	QTE.	DESCRIPTION
1	122001	1	CHASSIS
2	935010	2	ROUE
100	914703	2	GOUPILLE FENDUE
101	912023	2	RONDELLE

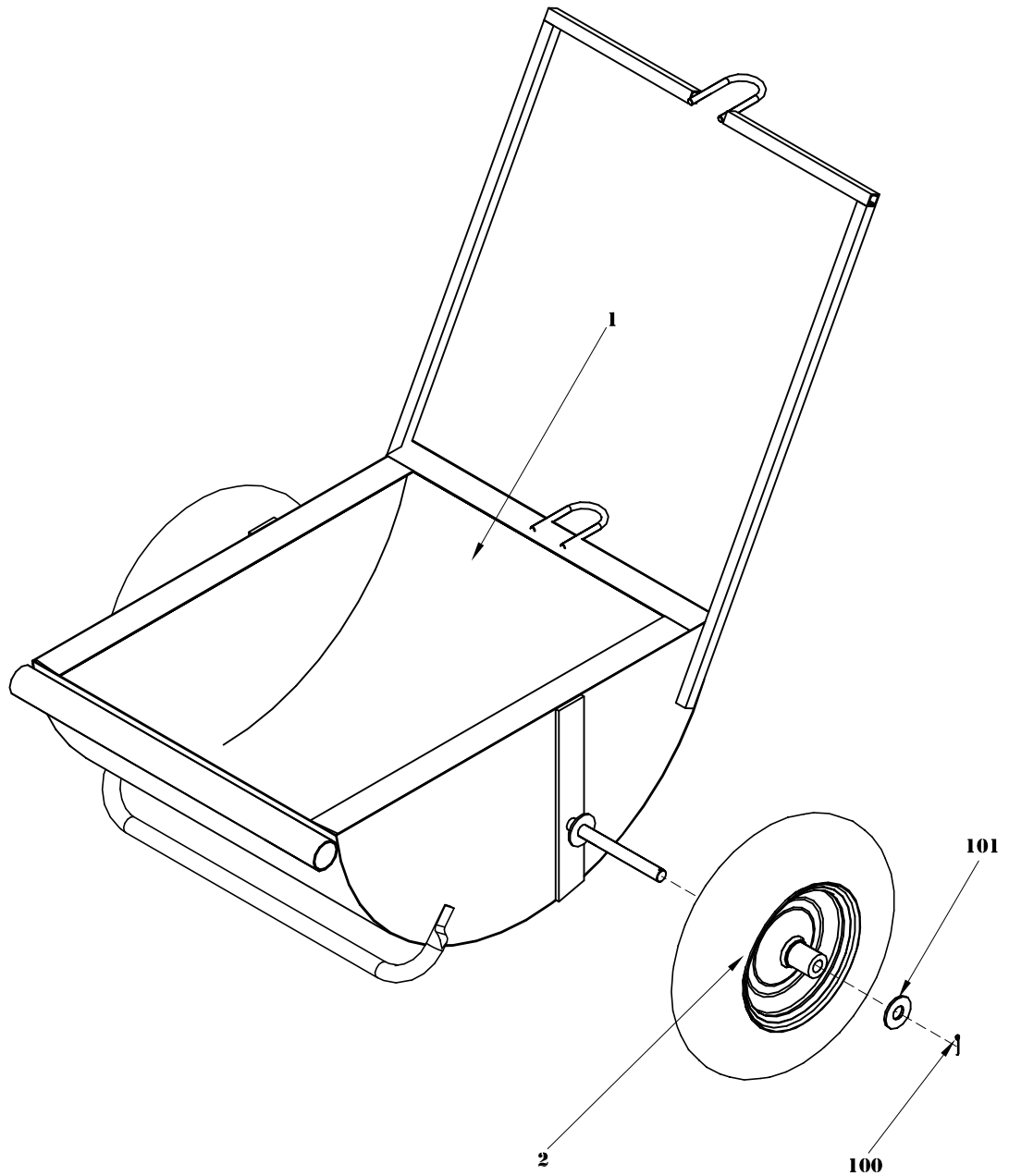

DATE:	01.08.2008	CHARIOT A MOPPE
REV.:	01.08.2008	
EQUIPEMENT GRIZZLY EQUIPEMENT		122000